

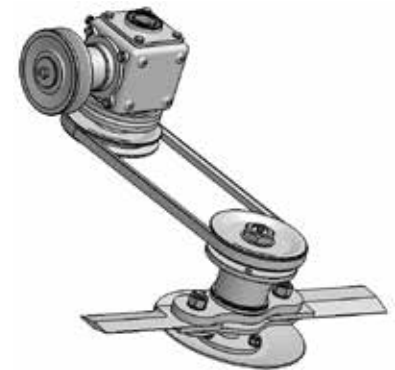

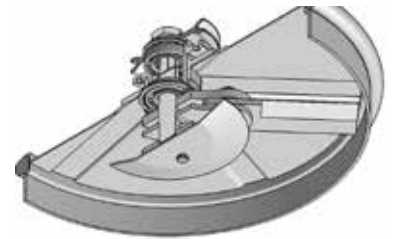

- Σύστημα προστασίας CE
- Ο μηχανικός και ο υδραυλικός πλαινός τροχός εφαρμόζονται στους τύπους V, F, FA, FRK, FRA, FRT, FRBK, FRBA, FRBT.
- CE protection system
- The mechanic and the hydraulic nearby wheel fits exactly at V, F, FA, FRK, FRA, FRT, FRBK, FRBA, FRBT.

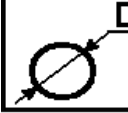

 D	 RPM			 Kg
400	2100	2	1	80
600	2100	2	1	90

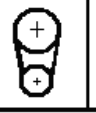
Τύπος Type	Κωδικός Code
Μηχανικός πλαινός τροχός Mechanic nearby wheel D600 D400	241120001
Υδραυλικός πλαινός τροχός Hydraulic nearby wheel D600 D400	241120101